



iBook

User's Guide · ユーザーズガイド · Manuel de l'utilisateur · Benutzerhandbuch
Manual del usuario · Manuale Utente · Guia do Usuário · Gebruikershandleiding · Handbok
Brukerhåndbok · Brugerhåndbog · Käsimkirja · 使用手冊 · 使用手冊 · 사용 안내서

To get started using your iBook, plug in the power adapter and connect a phone cord from a wall jack to the modem port. Then press the power button and follow the onscreen guide to connect to the Internet. Read on to learn more about using your iBook:



- 2 Your iBook at a glance
- 4 Mac OS X basics
- 8 What you can do with your iBook
 - 10 Listen to music on your computer or on the go
 - 12 Make your own movie or watch a movie on DVD
 - 14 Search the Internet
 - 16 Get more out of the Internet
 - 18 Send and receive email
 - 20 Organize, plan, and create
 - 22 Keep your iBook's software up-to-date
- 24 Learn more and solve problems
- 30 Install memory and an AirPort Card
- 34 Work more comfortably
- 36 Safety and cleaning

Your iBook at a glance

Your computer has these built-in features:

Volume and brightness controls
Adjust sound volume and screen brightness.

Two built-in stereo speakers
Listen to music, movies, games, and multimedia.

Optional AirPort wireless Internet and networking
(underneath keyboard)
Using the optional AirPort Card, you can connect to the Internet, use email, share files, play network games, and more—without any wires to hold you down.

Sleep indicator light
Pulsating light indicates that the computer is in sleep.



Built-in microphone
Record sound or control your computer with spoken commands.

Power button
Turn your computer on, put it to sleep, or shut it down.

Media Eject (F12) key
Press and hold to eject a CD or DVD or to open the optical drive tray.

Power adapter connector
Plug in the power adapter (included) to recharge your iBook's battery.

Optical disc drive
Install and run software or listen to music CDs. Play DVD videos if you have the DVD/CD-RW or Combo drive, or create your own CDs if you have the CD-RW or combo drive.



 **Kensington security slot**

Attach a lock and cable to prevent theft.

 **Modem**

Connect to the Internet, browse the World Wide Web, and send and receive electronic mail.

 **Ethernet**

Share files with another computer or access a computer network.

 **FireWire**

Connect a digital video camera and use it to create your own desktop movies. You can also connect FireWire hard disks, printers, and more.

 **USB**

Connect printers, Zip and other disk drives, digital cameras, joysticks, and more.

 **VGA port**

Connect an external monitor (using the included Apple VGA Display Adapter).

 **Reset button**

Use during troubleshooting to restart your computer.

 **Audio/video port**

Connect headphones or external speakers. Connect a TV or video projector using the optional Apple AV cable.

Battery level indicator

(underneath) When you press the button on the battery, one to four lights glow to show how much charge is left.

To learn more about your iBook's features:

- Choose Mac Help from the Help menu. Then click Go under "iBook at a glance."

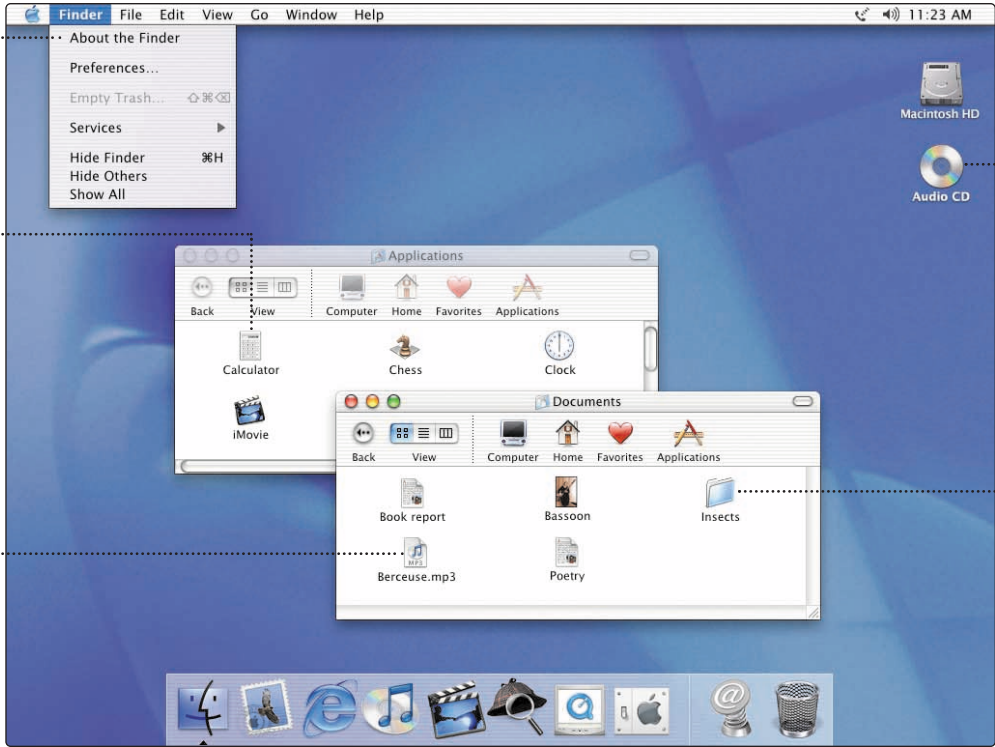

Application menu
Shows the name of the application you're using. Use to set preferences or quit applications (other than the Finder).

Application
Applications are software programs (such as a game or word processor) that you use with your computer. Double-click an application's icon to open the application.

Document
Documents are files that you create with an application (such as a letter you create with your word processor). Double-click the icon to open the file in the application used to create it.

Disc
This appears when a CD or DVD is in the disc drive. Double-click the icon to see what's on the disc. To eject a disc, press and hold the Media Eject (⏏) key on the keyboard.

Folder
Folders help organize your files and applications. Double-click a folder to see what's inside.

Dock
Click icons in the Dock to open applications, documents, folders, or minimized windows.

Change the Mac OS to suit your preferences.

There are lots of ways to customize Mac OS X.

To change Finder settings, choose Preferences from the Finder menu.

Choose System Preferences from the Apple menu to change most of your computer's settings.

To select a desktop background picture, open System Preferences and click Desktop.

To change the size of the Dock or move it to a different place, open System Preferences and click Dock.

To change icon sizes or the background of a Finder window, choose Show View Options from the View menu.

Click the icons in the Dock or toolbar to find and open files and applications.

▶ Drag applications, files, and folders into the Dock for one-click access.

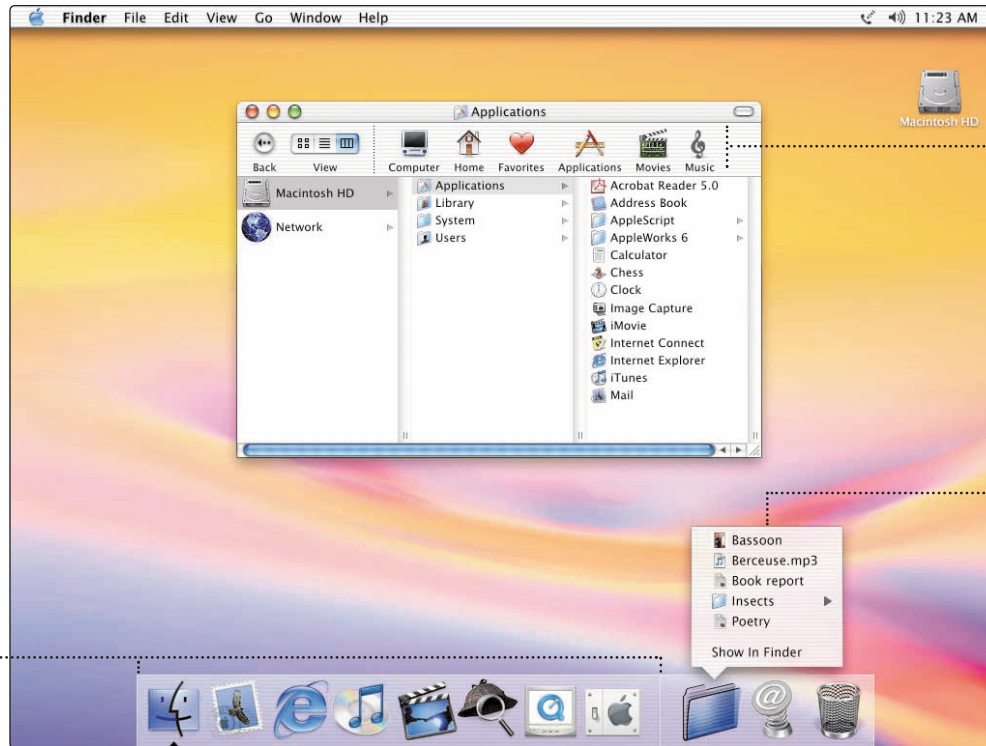

To set up the toolbar the way you want it, choose Customize Toolbar from the Finder's View menu, then drag items to the toolbar.

Press a folder icon to see its contents and open items in it.

This side of the Dock shows application icons.



The triangle indicates the application is open.

Drag this bar up or down to resize the Dock.

This side of the Dock shows files, windows, and folders.

What you can do with your iBook

Not sure how to get the most out of your new iBook? Read on for a few ideas.

Make your own CDs. Use iTunes  to transfer music from your CD collection. If your iBook has a CD-RW or Combo drive, burn your own music CDs. Transfer music to an iPod or other MP3 player to listen on the go. Make a movie. Shoot video on a DV camcorder and import it into iMovie . Then rearrange, edit, polish, and add titles and soundtracks. Connect to the Internet to send email and browse the Web, or use iTools  to post digital photos to the Web for everyone to see.

Browse through the next few pages to find out more.

The iBook is your digital hub.



Send digital photos to friends and family.



Import and edit homemade movies.



Send email and surf the 'Net.



Watch DVD movies.



Put 1,000 songs in your pocket.



Listen to music and burn your own CDs.

Listen to music on your computer or on the go.

Use iTunes to create a library of music and make your own CDs.

Library

Your collection of songs, imported from your own audio CDs or downloaded from the Internet. Easily browse or search for music.

Radio Tuner

Choose from hundreds of Internet radio stations – jazz, rock, talk, and more.

Audio CDs

Play an audio CD on your computer. Import songs to your Library to play them without the CD.



To learn more about iTunes:

- See iTunes Help, available in the Help menu.
- Go to www.apple.com/itunes

Burn CDs

If your iBook has a CD-RW or Combo drive, make your own audio CDs that play in standard CD players.

Playlists

Make personalized playlists using songs from your Library. Arrange your music by mood, artist, genre, or however you like.

Equalizer

Adjust the sound to your tastes using the 10-band EQ with 22 presets.

If you have an iPod, you can transfer up to 1,000 songs.

1. Connect iPod using the FireWire cable included with iPod. iTunes automatically transfers your music Library to iPod.
2. Unplug iPod.
3. Browse for a song on iPod and press the Play button.

To learn more about iPod:

- Open iTunes and choose iPod Help from the Help menu.
- Go to www.apple.com/ipod

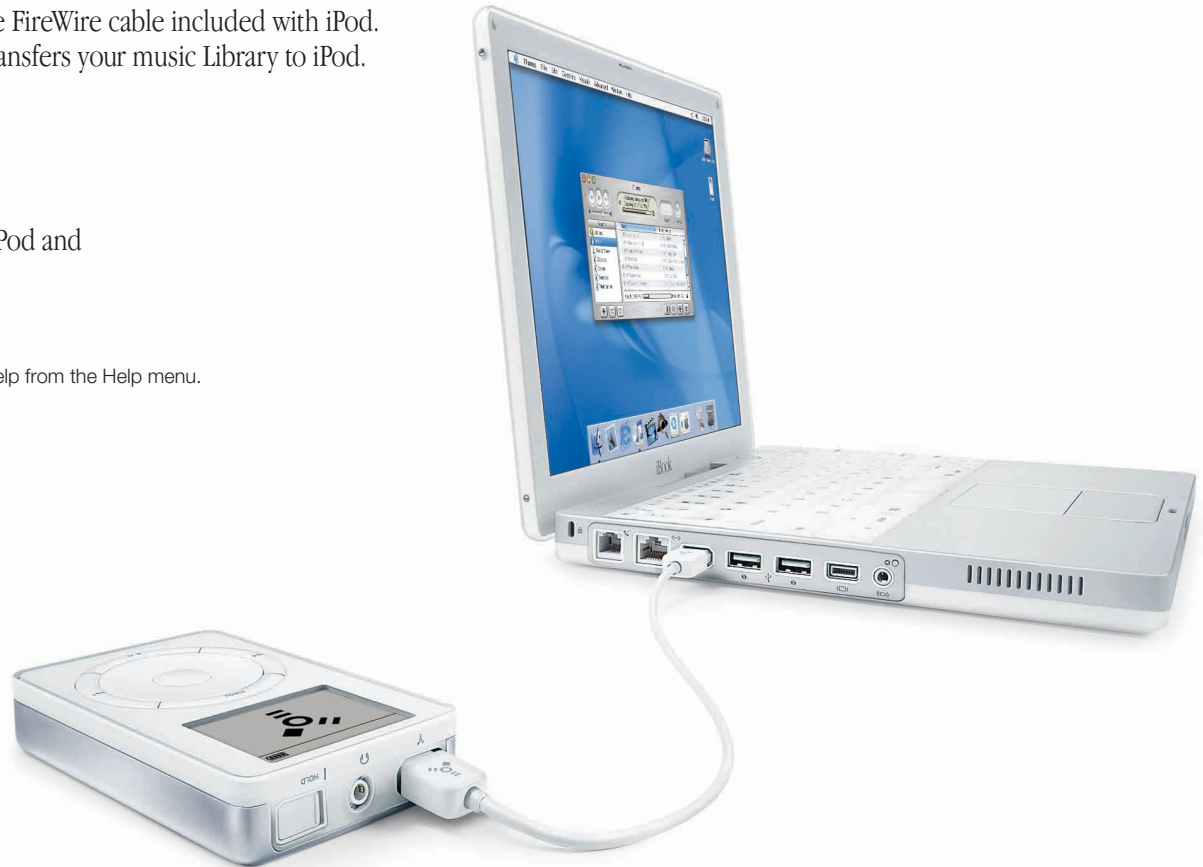

Make your own movie or watch a movie on DVD.

Use iMovie to edit video from a digital video camera.

▶ Shoot video with a digital video camera. Then connect the camera using a 6-pin to 4-pin FireWire cable and import your clips.

iMovie monitor

Preview your movie or view video from a connected DV camera.



Viewers

Click the clip viewer (eye tab) to edit and place clips. Click the timeline viewer (clock tab) to edit sound.

Playback controls

Use these to play the movie in the iMovie monitor. Click the Play Full Screen button to use the entire screen.

▶ You can export your finished movie to a tape in your DV camera or to a QuickTime file.

Shelf

Clips appear here when you import them. Move clips to the viewer to make them part of your movie.

Editing buttons

Click to open panels for adjusting and selecting sounds, video effects, titles, and transitions.

To learn more about iMovie:

- Open iMovie and choose iMovie Help from the Help menu.
- Go to www.apple.com/store to find compatible DV cameras or to purchase a FireWire cable.

If your computer has a DVD drive or Combo drive, you can watch DVD movies.



To learn more about DVD Player:

- Choose DVD Player Help from the Help menu.

1. Insert a DVD video disc. DVD Player opens automatically.

2. Use the controller to play the movie or see the DVD's special features.

Search the Internet.

If you know the Internet address, you can go there directly.

▶ If you have a dialup connection, you can use the modem status icon (📠) to connect to and disconnect from the Internet.

To learn more about Internet Explorer:

- Open Internet Explorer and choose Internet Explorer Help from the Help menu.

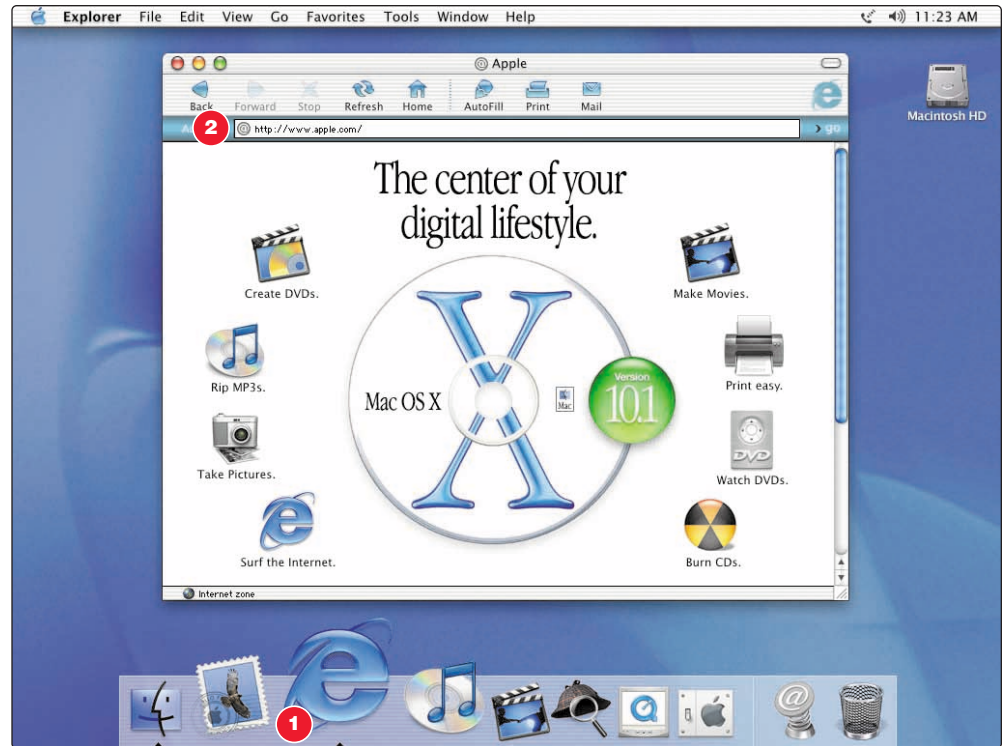

1. Click the icon in the Dock to open Internet Explorer.

2. Type the Internet address and press Return on your keyboard.

Or you can search the Internet with Sherlock.

- ▶ Click the other buttons to find people, read the news, shop, and more.
- ▶ Click the hard disk icon to search the files on your computer.



1. Click the icon in the Dock to open Sherlock.
2. Click the Internet icon and type a question in the search field.
3. Click the Search button (Q). Then double-click an item in the list of sites.

Get more out of the Internet with iTools.

iTools is a suite of Internet services integrated into Mac OS X.



iDisk

Your own storage space on Apple's Internet server. Share photos, movies, and other files over the Internet. Access your files from another Macintosh or PC.



HomePage

Build a personal Web site in three easy steps. Create a photo album, publish an iMovie, post your résumé, and more. Anyone can view your site on the World Wide Web.



iCards

Send an elegant iCard, just right for any occasion. Choose a ready-made photo, or create a personalized iCard using a photo on your iDisk.



Email

Get your own Mac.com email address. It's easy and works with your favorite email application.

To learn more about iTools:

- Go to www.apple.com/itools and click Help on the iTools menu bar.



▶ If you signed up for iTools when you first turned on your computer, you already have an account. Go to www.apple.com/itools to get started.

▶ To sign up for a new iTools account, open System Preferences and click Internet. Then click Sign Up.

Store pictures, movies, documents, and other files remotely.

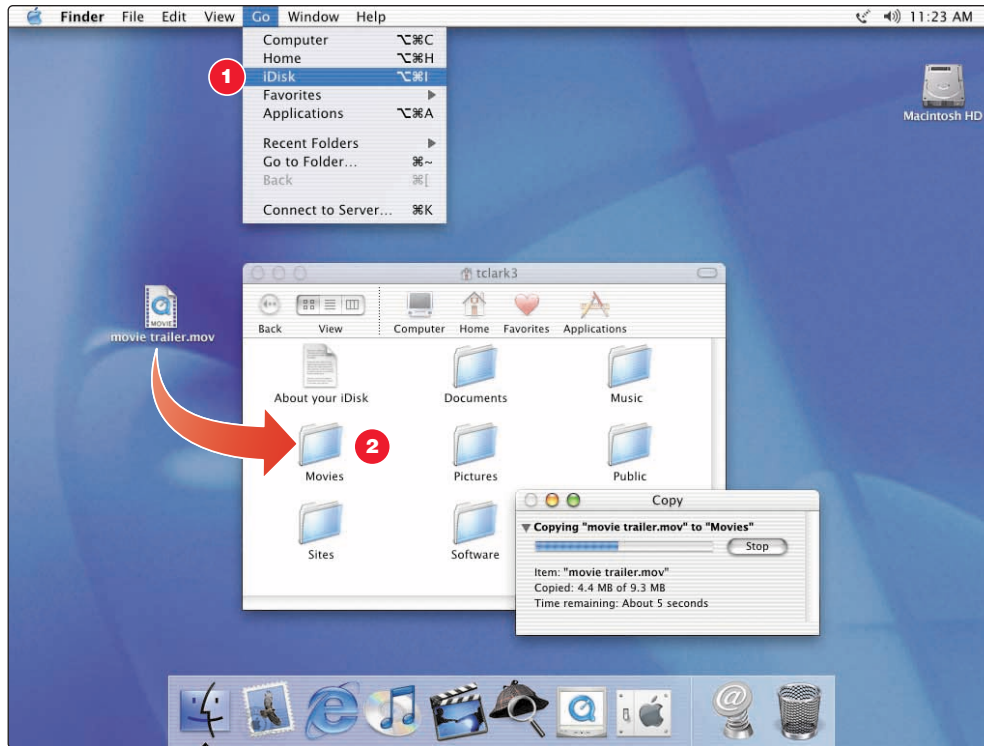

- ▶ To access your files from another computer, log into your iTools account at www.apple.com/itools
- ▶ Anyone can access the files in your Public folder.
- ▶ To find out how to use pictures and other files from your iDisk to create a personal Web site, go to www.apple.com/itools and click the HomePage icon.

1. Choose iDisk from the Go menu.

2. Drag files to a folder on your iDisk to copy them.

Send and receive email.

Follow these steps to create and send a message.

- ▶ To check for new messages, click Get Mail.
To view a message, click its subject.
- ▶ If you entered email information or got a Mac.com account when you first turned on your computer, Mail is already set up. To set up a new email account, choose Preferences from the Mail menu, then click Accounts.

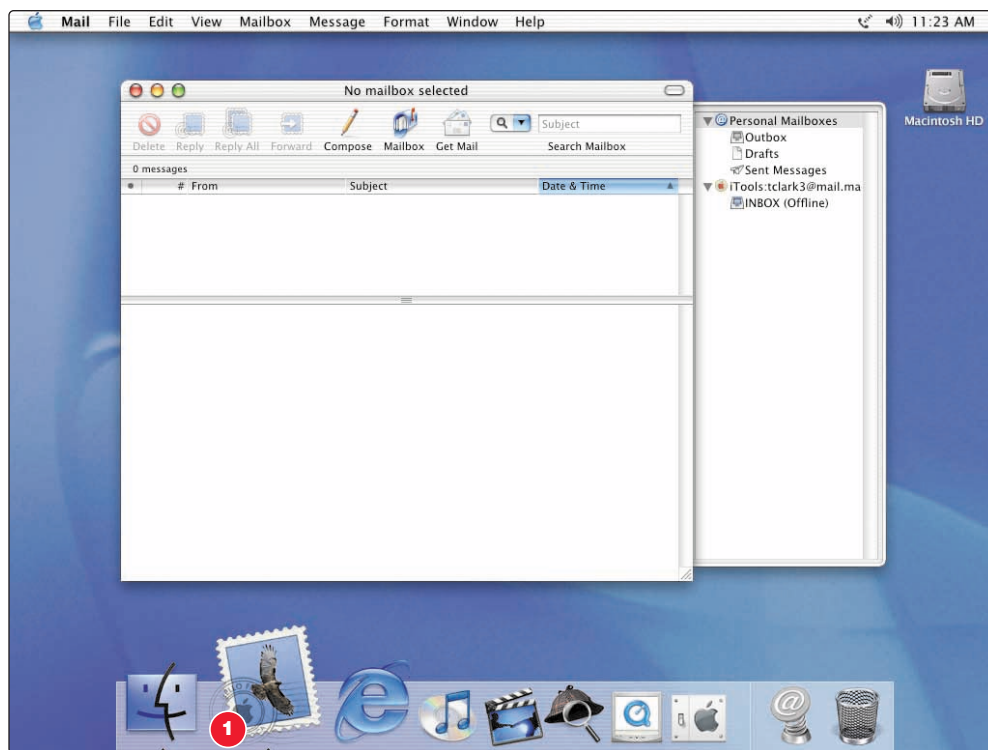

1. Click the Mail icon in the Dock to open the Mail application.

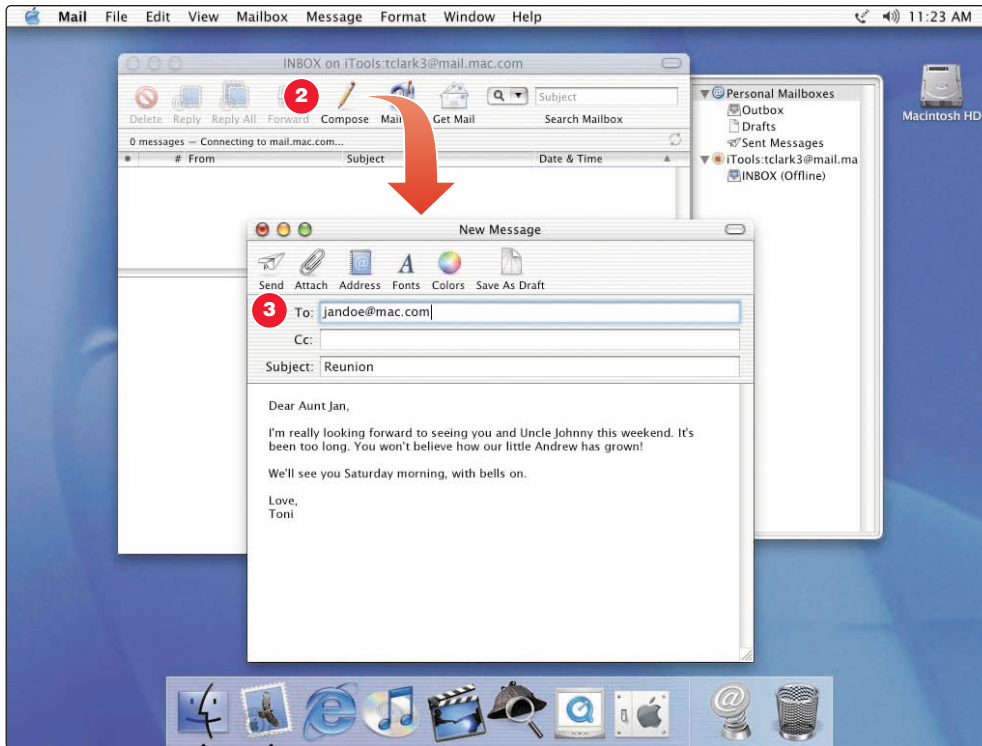

To learn more about Mail:

- Open Mail, then choose Mail Help from the Help menu.
- Go to www.apple.com/macosx/applications/mail.html

2. To create a new email message, click Compose.

3. Type the email address and a subject. Then type your message and click Send.

Organize, plan, and create using AppleWorks.

Use AppleWorks for writing, drawing, making presentations, and more.

Layout capabilities

Add photos, tables, charts, and sidebars. Link text frames, layer graphics, and wrap text.

Word processing

Write letters, create brochures, make greeting cards and party invitations.

Presentation tool

Create an onscreen slide presentation. Add movies, art, graphs, and charts.

Database

Keep records, save addresses, make inventories. Merge mailing information with the word processor to send form letters.

Make Cooking Fun, Fresh, and Fast

Duis autem vel eum iriure dolor in hererit in vulputate velit esse molestie consequat, vel illum dolore eu feugiat nulla facilisis vero accumsan et iusto odio dignissim.

Making a Perfect Brew

Ut wisi enim ad minim veniam, quis nostrud exerci tation ullamcorper suscipit lobortis nisl ut aliquip ex ea commodo consequat. Duis autem vel eum iriure dolor in hendrerit in vulputate velit esse.

Cooking Dinner for Six

Ut wisi enim ad minim veniam, quis nostrud exerci tation ullamcorper suscipit lobortis nisl ut aliquip ex ea commodo consequat. Duis autem vel eum iriure dolor in hendrerit in vulputate velit esse.

Nutritional Tips

Food pyramid	Groups	Examples	Nutrients	Diet	Web link
	Fats	Candy	None	0.1%	www.fats.com
	Dairy & meat	Cheese & fish	Calcium & protein	13%	www.dairymeats.com
	Fruit & vegies	Apple & carrot	Vitamins & minerals	33%	www.fruitvegies.com
	Grains	Bread	Fiber	41%	www.fibergrains.com

Gourmet News

324 Sunview Way
San Ramon, CA 94788
phone 925 555 5666
fax 925 555 5600

Customizable templates

Choose from a wide range of predesigned documents and modify them as needed.

Spreadsheet

Compute data easily using over 100 built-in functions, then use formatting options to make it stand out.

Painting

Create art from scratch or apply effects to existing pictures or scanned photos.

Extensive clip art libraries

Choose from over 25,000 high-quality clip art images.



To get started using AppleWorks:

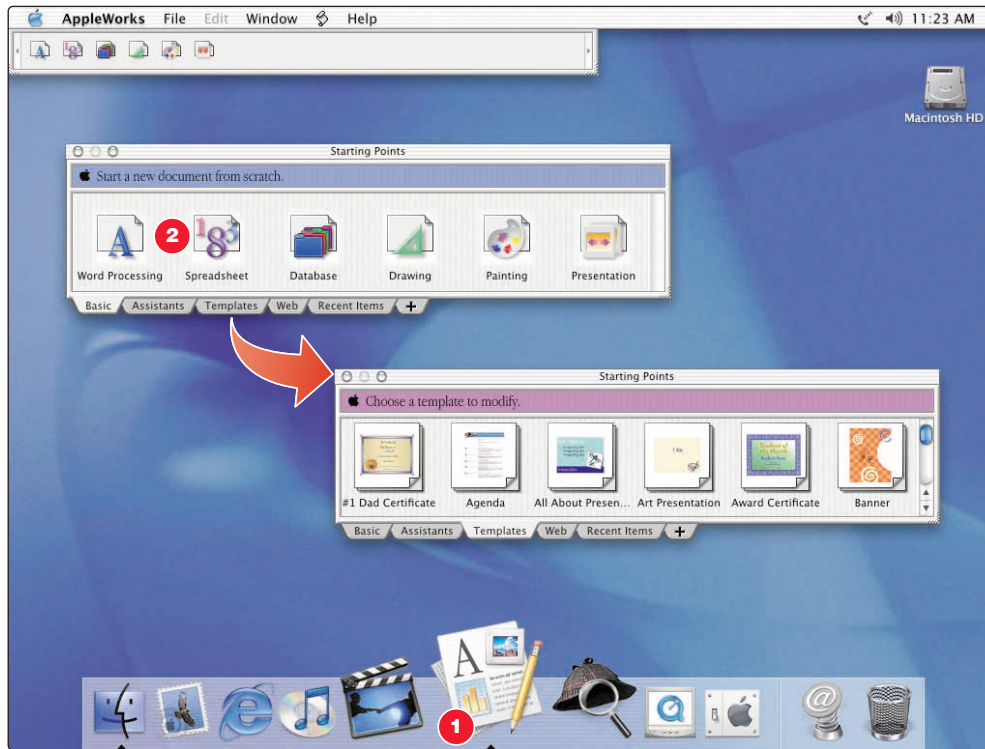

▶ Click the Web tab to download more templates from the Internet.

1. Click the icon in the Dock to open AppleWorks.

2. Click the type of document you want to create, or click the Templates tab to modify a ready-made document.

To learn more about AppleWorks:

- See AppleWorks Help, available in the Help menu.
- Go to the AppleWorks Web site at www.apple.com/appleworks

Keep your iBook's software up-to-date.

Use Software Update to get the latest updates and drivers.

► To use Software Update, you must have an Internet connection.



1. Click the icon in the Dock to open System Preferences.

2. Click Software Update.



- ▶ Click the name of a software item to learn more about it.
- ▶ You can schedule your computer to check automatically for software updates.

3. Then click Update Now.

4. Select the software you want to update and then click Install.

Learn more about using your computer.

Look in Mac Help for more information on using your computer.

- ▶ To browse the features of your computer, click Go under “At a glance.”
- ▶ Click Quick Clicks topics for answers to frequently asked questions.
- ▶ To look at Help for other applications, click the ? button.

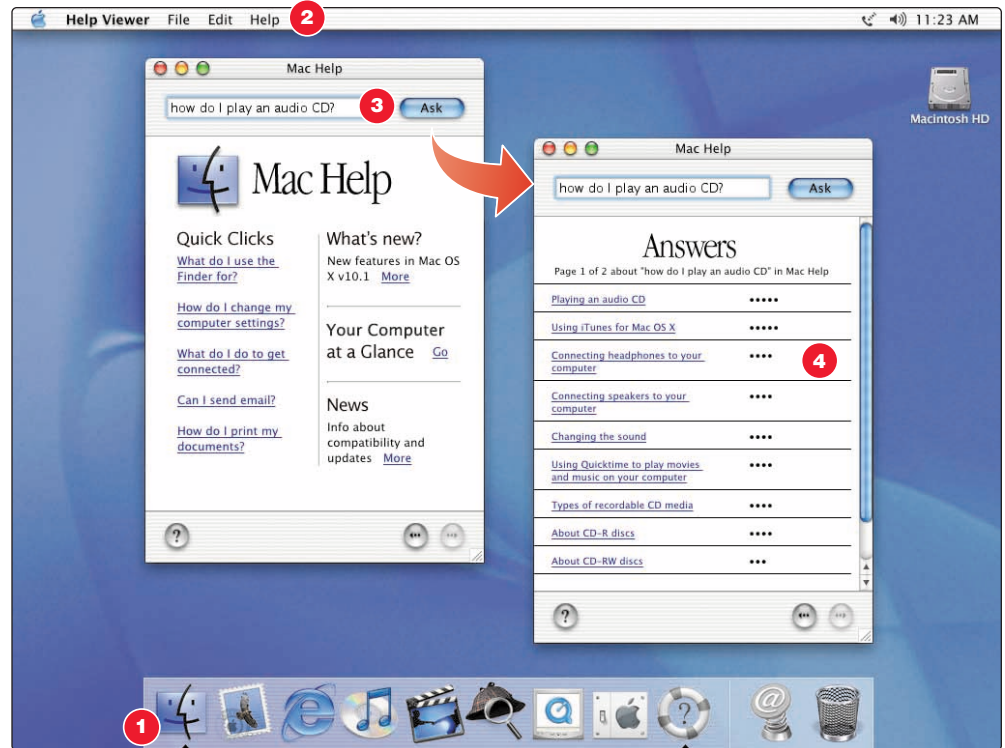

1. Click the Finder icon in the Dock.
2. Then choose Mac Help from the Help menu.
3. Type a question and click Ask.
4. Click an item in the list of Help topics.

These Apple Web sites will help you get the most out of your computer.

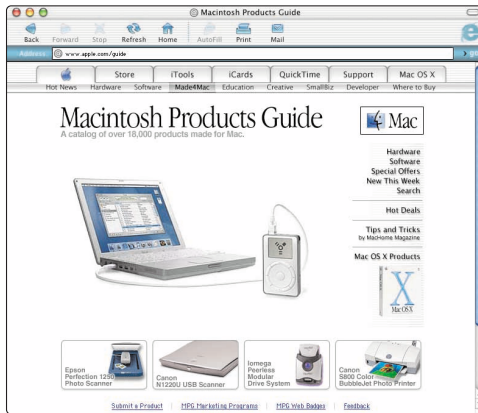

Macintosh Products Guide

www.apple.com/guide



For great hardware and software products for your Mac, check the Web site or look for the Mac symbol. Also get contact and support information for third-party software manufacturers.

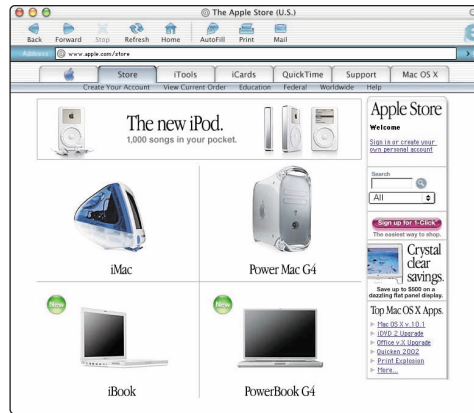

Apple Store

www.apple.com/store

Purchase the latest Apple and third-party hardware, software, and accessories.



Apple Service and Support

www.apple.com/support

Product support, software updates, and technical information.

► From these Web sites you can quickly link to other Apple Web sites around the world.

Advice and troubleshooting

If you don't find the answer to your problem on the following pages:

Look in Mac Help.

- In Mac Help (see page 24), you can find a great deal of troubleshooting advice, including information to help you solve problems with
 - Connecting to the Internet
 - Using software installation and restore discs
 - Changing your computer's settings
 - Printing
 - And more
- Click the Finder icon in the Dock, then choose Mac Help from the Help menu. Type a question in the search window (for example, type "How do I eject a disc?") and click Ask.

Switching between Mac OS X and Mac OS 9

Your iBook is set to use Mac OS X. Most applications made for Mac OS 9 will work in the Mac OS X Classic environment. Just open the application as you normally would. You can also start up your computer using Mac OS 9.

To set your computer to use Mac OS 9:

- Choose System Preferences from the Apple (🍏) menu in Mac OS X.
- Click the Startup Disk icon to open the Startup Disk pane.
- Select the Mac OS 9 folder as your startup disk. If the icons are dimmed, click the padlock icon and enter the password you chose when you first set up Mac OS X.
- Click Restart.

To set your computer to use Mac OS X again:

- Choose Control Panels from the Apple (🍏) menu.
- Open the Startup Disk control panel.
- Click the triangle next to the hard disk that contains your operating system folders.
- Select the Mac OS X System as your startup disk.
- Click Restart.

If the computer won't respond:

Try to cancel what the computer is doing.

- Try to force problem applications to quit. Hold down the Option and Command (⌘) keys, then press the Esc key. Select the application and click Force Quit.

If that doesn't work, restart the computer.

- Hold the Power button for several seconds. When the computer turns off, press the Power button again to restart it.
- If that doesn't work, hold down the Control and Command (⌘) keys and then press the Power button.
- If that doesn't work, gently press the Reset (⏻) button by inserting the end of a paper clip into the small hole above the audio/video port, wait a few seconds, and then press the Power (⏻) button.

Then do this:

If the problem occurs frequently when you use a particular application:

- Check with the application's manufacturer to see if it is compatible with your computer.
- For support and contact information about the software that came with your computer, go to www.apple.com/guide

If the problem occurs frequently:

- You may need to reinstall your system software. Choose Mac Help from the Help menu and type "install system software" for more information.

If you see a flashing question mark during startup:

If the computer doesn't start up after a delay, hold down the Option key and restart your computer.

- When your computer starts up, click the hard disk icon, then click the arrow.

Then do this:

After the computer starts up:

- Open System Preferences and click Startup Disk. Select a local Mac OS X System folder.

If the problem occurs frequently:

- You may need to reinstall your system software. Choose Mac Help from the Help menu and type "install system software" for more information.

If the computer won't turn on or start up:

First, make sure the power adapter is plugged into the computer and into a functioning power outlet.

- Your battery may need to be recharged. Press the small button on the battery. One to four lights glow indicating the battery's level of charge.

If that doesn't work or if you hear a strange sound during startup:

- If you recently installed additional memory, make sure that it is correctly installed. Try removing the memory; if the computer starts up normally, the memory is not compatible with your computer.
- If that doesn't work, gently press the Reset (⏻) button by inserting the end of a paper clip into the small hole above the audio/video port, wait a few seconds, and then press the Power (⏻) button.
- See the service and support information that came with your iBook for information on having your computer serviced.

If you can't log into your computer:

Make sure you are typing your user name and password correctly.

- Make sure you are using the same capitalization and punctuation that you used originally. Check to see if the Caps Lock key has been pressed.

If that doesn't work, reset your password.

- Insert the Mac OS X software install CD that came with your computer. Restart your computer while holding down the C key. When the Installer appears, choose Reset Password from the Installer menu and follow the onscreen instructions.

If you can't eject a CD or DVD or open the optical drive tray:

Make sure the disc is not in use.

- Quit all applications that are using files on the disc.
- Then press the Media Eject (⏻) key at the top-right corner of the keyboard.
- If that doesn't work, hold down the function (fn) key and press the Media Eject key.
- If that doesn't work, drag the disc's icon to the Trash.
- If that doesn't work, restart the computer, then hold down the mouse button. To restart, choose Restart from the Apple (Ⓜ) menu.

If the disc still won't eject, eject it manually:

- Carefully insert the end of a straightened paper clip into the emergency eject hole on the drive tray.

Other problems:

If you have a problem with your Internet connection:

- Make sure the telephone line is connected to the modem (📞) port and the line is functioning properly.

If that doesn't work, make sure your Internet settings are configured correctly.

- Open the Internet Connect application in the Applications folder to check your dialup or AirPort settings. Open System Preferences and click Network to check your Internet settings.
- If you're not sure of the correct information for your Internet settings, contact your Internet service provider.

If you have a problem connecting other devices:

- Make sure that the device is properly connected. Try unplugging and plugging in the device again.
- Check to see if the device has software that needs to be installed.
- If that doesn't work, contact the device manufacturer.

If you have a problem with an application:

- For problems with software, contact the software manufacturer.
- For support and contact information about the software that came with your computer, go to www.apple.com/guide

If you didn't find the information you were looking for on this page:

- Look in Mac Help. Click the Finder icon in the Dock, then choose Mac Help from the Help menu. Type a question in the search window (for example, type "How do I eject a disc?") and click Ask.

If you suspect there may be a problem with your computer hardware:

- You can use the Apple Hardware Test CD to help you determine if there is a problem with one of your computer's components, such as the memory or processor.

Install memory and an AirPort Card.

For detailed instructions, refer to Mac Help (see page 24).

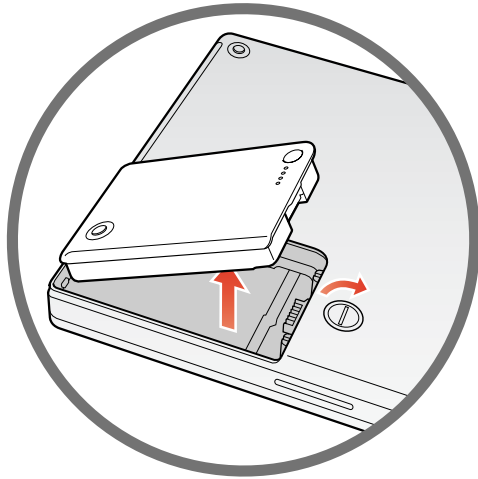

1. Shut down your computer. Then disconnect the power adapter and phone cord. Turn the computer over and remove the battery.

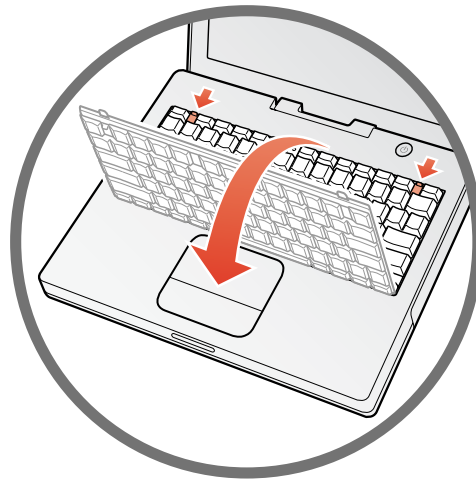

2. Release the keyboard by sliding the two plastic tabs away from the display. Then lift the keyboard, flip it over, and lay it on the palm rests.

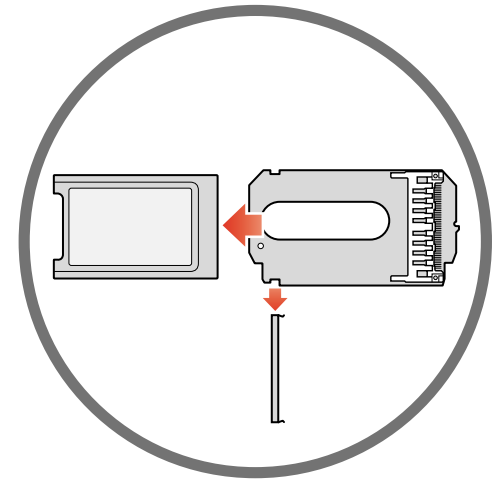

3. If necessary, remove the metal clip and pull the AirPort Card from the adapter. The adapter is not used with the iBook.

▶ If the keyboard doesn't pop up, it may be locked. Locate the plastic tab next to the Num Lock key. Use a small flathead screwdriver to turn the screw counter-clockwise 1/2 turn.

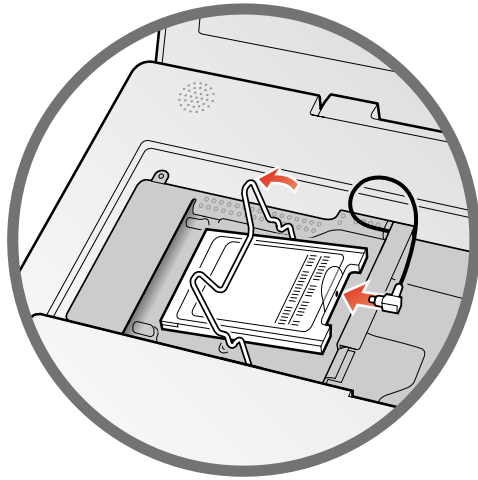

4. Flip up the wire bracket and connect the end of the antenna to the AirPort Card. Touch a metal surface inside the computer.

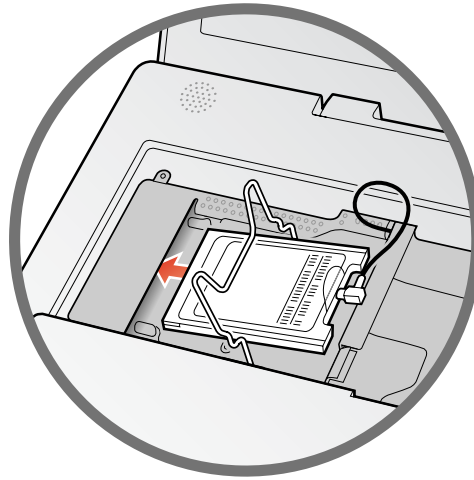

5. Slide the AirPort Card (with the AirPort ID and barcode facing up) under the wire bracket and into the slot.

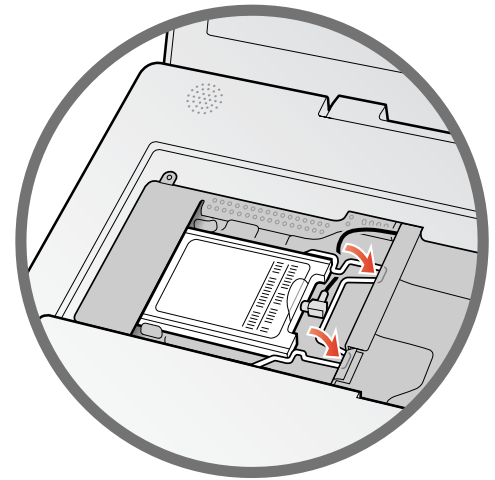

6. Press the wire bracket down to secure the card. Then replace the keyboard and battery.

Add additional memory.

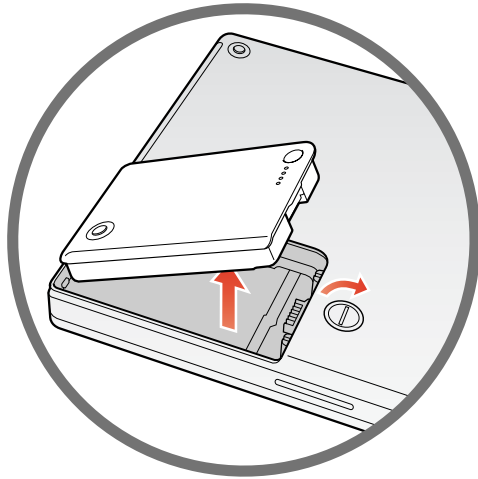

1. Shut down your computer. Then disconnect the power adapter and phone cord. Turn the computer over and remove the battery.



2. Release the keyboard by sliding the two plastic tabs away from the display. Then lift the keyboard, flip it over, and lay it on the palm rests.

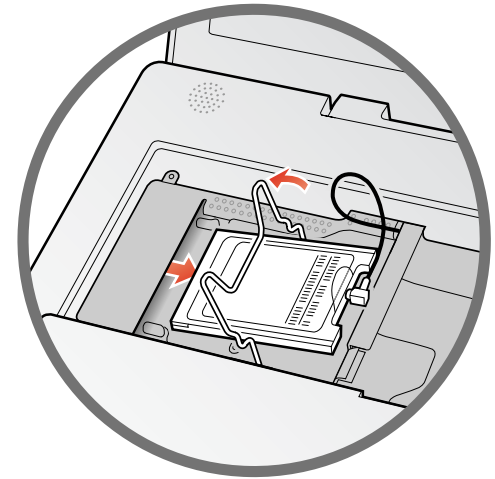

3. If necessary, remove the AirPort Card.

► Your iBook has one expansion slot that accepts a standard PC-100 compliant, SO-DIMM memory module (1.25-inch or shorter). For more information on installing memory, look in Mac Help, available in the Help menu.

► If the keyboard doesn't pop up, it may be locked. Locate the plastic tab next to the Num Lock key. Use a small flathead screwdriver to turn the screw counter-clockwise 1/2 turn.

► To prevent scratching, place a soft cloth between the AirPort Card and the iBook case.

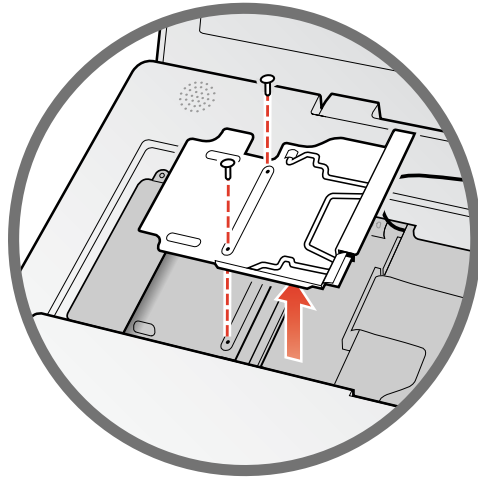

4. Remove the two screws that secure the RAM shield, then carefully lift it out.

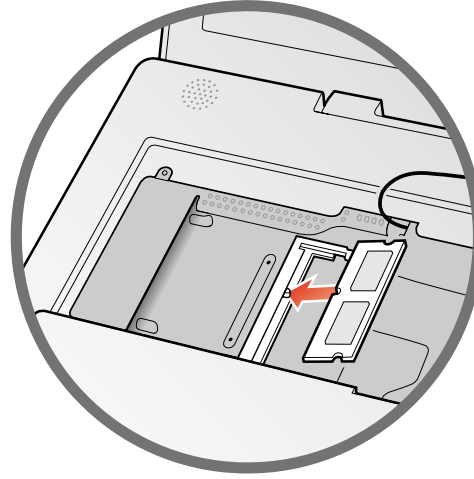

5. Insert the RAM into the slot at an angle and press down to lock it in place. Replace the RAM shield and AirPort Card (if necessary).

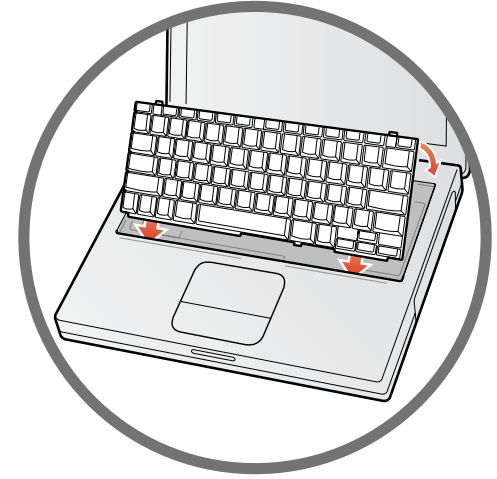

6. Replace the keyboard and battery.

► For more information on the type of memory to use with your computer, choose Mac Help from the Help menu. Then type “memory” and click Ask.

► If you already have a memory card installed, remove it first.

► Never turn your computer on unless all of its internal and external parts are in place.

Work more comfortably

Keyboard and trackpad

When you use the keyboard and trackpad, your shoulders should be relaxed. Your upper arm and forearm should form an angle that is slightly greater than a right angle, with your wrist and hand in roughly a straight line.

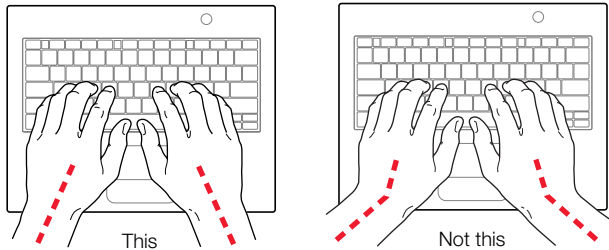

Use a light touch when typing or using the trackpad and keep your hands and fingers relaxed. Avoid rolling your thumbs under your palms.

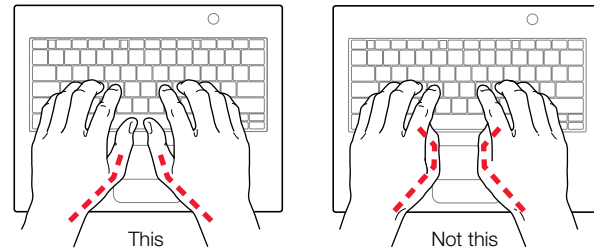

Change hand positions often to avoid fatigue. Some computer users may develop discomfort in their hands, wrists, or arms after intensive work without breaks. If you begin to develop chronic pain or discomfort in your hands, wrists, or arms, consult a qualified health specialist.

Chair

An adjustable chair that provides firm, comfortable support is best. Adjust the height of the chair so your thighs are horizontal and your feet flat on the floor. The back of the chair should support your lower back (lumbar region). Follow the manufacturer's instructions for adjusting the backrest to fit your body properly.

You may have to raise your chair so your forearms and hands are at the proper angle to the keyboard. If this makes it impossible to rest your feet flat on the floor, you can use a footrest with adjustable height and tilt to make up for any gap between the floor and your feet. Or you can lower the desktop to eliminate the need for a footrest. Another option is to use a desk with a keyboard tray that's lower than the regular work surface.

External mouse

If you use an external mouse, position the mouse at the same height as your keyboard and within a comfortable reach.

Built-in display

Adjust the angle of the display to minimize glare and reflections from overhead lights and windows.

You can adjust the brightness of the screen when you take the computer from one work location to another, if the lighting in your work area changes.

For more information

For additional ergonomic information, see the Apple ergonomic Web site at www.apple.com/about/ergonomics

Safety and cleaning

When setting up and using your computer, remember the following:

- Read all the installation instructions carefully before you plug your computer into a wall socket.
- Keep these instructions handy for reference by you and others.
- Follow all instructions and warnings dealing with your system.
- Use only the Apple Portable Power Adapter that came with your computer. Adapters for other electronic devices may look similar, but they may damage your computer.
- Always leave space around your power adapter. Do not use this equipment in a location where airflow around the power adapter is confined, such as a bookcase.
- Always disconnect the power adapter, phone line, and any other cables before opening the computer to perform procedures such as installing memory.
- Never turn on your computer unless all of its internal and external parts are in place. Operating the computer with missing parts can be dangerous and damage your computer.
- Do not connect a digital telephone line to the modem, because the wrong type of line could damage the modem.
- When using your computer or when charging the battery, it is normal for the bottom of the case to get warm. The bottom of the computer case functions as a cooling surface that transfers heat from inside the computer to the cooler air outside. The bottom of the case is raised slightly to allow airflow that keeps the unit within normal operating temperatures.
- Keep your computer away from sources of liquids, such as drinks, washbasins, bathtubs, shower stalls, and so on.
- Protect your computer from dampness or wet weather, such as rain, snow, and so on.

Warning Electrical equipment may be hazardous if misused. Operation of this product, or similar products, must always be supervised by an adult. Do not allow children access to the interior of any electrical product and do not permit them to handle any cables. Never push objects of any kind into this product through the openings in the case. Doing so may result in fire or a dangerous electric shock.

For your own safety and that of your equipment, always disconnect the power plug (by pulling the plug, not the cord), disconnect the phone line, and remove the battery if any of the following conditions exists:

- you want to remove any parts (leave the power cord disconnected as long as the keyboard is open)
- the power cord or plug becomes frayed or otherwise damaged
- you spill something into the case
- your computer is exposed to rain or any other excess moisture
- your computer has been dropped or the case has been otherwise damaged
- you suspect that your computer needs service or repair
- you want to clean the case (use only the recommended procedure)

Important The only way to disconnect power completely is to unplug the power plug, disconnect the phone cord, and remove the battery. Make sure at least one end of the power cord is within easy reach so that you can unplug the computer when you need to.

Warning To avoid damage to your computer, Apple recommends that only an Apple-certified technician install additional RAM or an AirPort Card. Consult the service and support information that came with your computer for instructions on how to contact an Apple-authorized service provider or Apple for service. If you attempt to install additional RAM or an AirPort Card yourself, any damage you may cause to your equipment will not be covered by the limited warranty on your computer. See an Apple-authorized dealer or service provider for additional information about this or any other warranty question.

Your iBook has a unique appearance and finish that may contain minor imperfections, some of which may increase over time. Exposing your iBook to extreme temperatures or humidity may cause this process to accelerate. Proper care and handling, as described in this manual, will help keep your iBook looking its best.

To clean the case, do the following:

- 1 Disconnect the power plug and phone cord and remove the battery. (Pull the plug, not the cord.)
- 2 Wipe the surfaces lightly with a clean, soft cloth.

Warning Do not use any substance containing isopropyl alcohol. It can damage the case. If necessary, use products made specifically for cleaning computers.

Where's the fine print?

Communications, Telephone, and Modem Regulation Information

For information on FCC regulations, radio and television interference, and telephone and modem information related to this product, see the files in the Communications Regulations folder, inside the Documents folder on your hard disk.

Laser Information

Warning Making adjustments or performing procedures other than those specified in your equipment's manual may result in hazardous radiation exposure.

Do not attempt to disassemble the cabinet containing the laser. The laser beam used in this product is harmful to the eyes. The use of optical instruments, such as magnifying lenses, with this product increases the potential hazard to your eyes. For your safety, have this equipment serviced only by an Apple-authorized service provider.

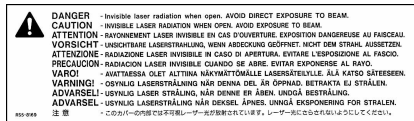

Service Warning Label

Apple Portable Power Adapter

The Apple Portable Power Adapter that comes with your computer is a high-voltage component and should not be opened for any reason, even when the computer is turned off. If your computer needs service, contact your Apple-authorized dealer or service provider.

Battery

Warning Risk of explosion if battery is replaced by an incorrect type. Dispose of used batteries according to your local environmental guidelines. Do not puncture or incinerate.

High-Risk Activities Warning

This computer system is not intended for use in the operation of nuclear facilities, aircraft navigation or communications systems, or air traffic control machines, or for any other uses where the failure of the computer system could lead to death, personal injury, or severe environmental damage.

iPod Information

The Apple iPod pictured on page 11 of this manual is not included with this product. For more information on iPod, go to www.apple.com/ipod

ENERGY STAR®

As an ENERGY STAR® partner, Apple Computer has determined that standard configurations of this product meet the ENERGY STAR® guidelines for energy efficiency. The United States Environmental Protection Agency's ENERGY STAR® program is a partnership with office product equipment manufacturers to promote energy-efficiency. Reducing energy consumption of office products saves money and reduces pollution by eliminating wasted energy.

This information applies to the standard configurations of the computer using the Mac OS X operating system.

Every effort has been made to ensure that the information in this manual is accurate. Apple is not responsible for printing or clerical errors.

www.apple.com

© 2002 Apple Computer, Inc. All rights reserved.

AirPort, Apple, the Apple logo, AppleWorks, FireWire, the FireWire logo, iBook, Mac, the Mac logo, Macintosh, QuickTime, and Sherlock are trademarks of Apple Computer, Inc., registered in the U.S. and other countries. Finder, iMovie, iPod, and iTunes are trademarks of Apple Computer, Inc. ENERGY STAR® is a U.S. registered trademark. Digital imagery copyright 1998 PhotoDisc, Inc.

034-2095-A Printed in Taiwan